

FIMER



Solar Inverter

TRIO-5.8/7.5/8.5-TL-OUTD

Quick Installation Guide

In addition to what is explained in this quick installation guide, the safety and installation information provided in the product manual must be read and followed. The technical documentation for the product is available at the website.

The device must be used in the manner described in the manual. If this is not the case the safety devices guaranteed by the inverter might be ineffective.

**APPLY HERE
THE WIRELESS
IDENTIFICATION LABEL**

1. Labels and Symbols

The labels on the inverter have the Agency marking, main technical data and identification of the equipment and manufacturer

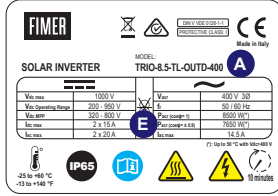

- 1 Inverter model
- 2 Inverter part number
- 3 Inverter serial number
- 4 Week/Year of manufacture
- 5 Main technical data

ATTENTION – The labels attached to the equipment must NOT be removed, damaged, dirtied, hidden, etc...
If the service password is requested, use the serial number field -SN: YYWWSSSSSS- shown on the identification label (affixed to the side)

In the manual and/or in some cases on the equipment, the danger or hazard zones are indicated with signs, labels, symbols or icons.

	Always refer to instruction manual		Hot surfaces		Without insulation transformer
	General warning - Important safety information		Protection rating of equipment		Direct and alternating current, respectively
	Dangerous voltage		Temperature range		Positive and negative pole of the input voltage (DC)
	Obligation to use protective clothing and/or personal protective equipment		Point of connection of the protective ground		The discharge time of the stored energy

2. Inverter models and components

The inverter model should be chosen by a specialized technician who has a good knowledge of the installation conditions, the devices that will be installed externally, and whether it will eventually be integrated into an existing system.
The following models of inverter are available(08):

TRIO-5.8-TL-OUTD-400 TRIO-5.8-TL-OUTD-S-400

- | | |
|--|--|
| • Number of input channels: 1 | • Number of input channels: 1 |
| • DC disconnect switch (08): No | • DC disconnect switch (08): Yes |
| • Input connectors: screw terminal block | • Input connectors: quick fit connectors (2 pairs) |

TRIO-7.5-TL-OUTD-400 TRIO-7.5-TL-OUTD-S-400

TRIO-8.5-TL-OUTD-400 TRIO-8.5-TL-OUTD-S-400

- | | |
|--|--|
| • Number of input channels: 2 | • Number of input channels: 2 |
| • DC disconnect switch (08): No | • DC disconnect switch (08): Yes |
| • Input connectors: screw terminal block | • Input connectors: quick fit connectors (2 pairs per channel) |

Main components

01 Display	11 Handles
02 LED panel	12 Heat sink
03 Keypad	13 Bracket
04 Front cover	14 Locking screw
05 AC output board	15 AC cable gland
06 Communication and control board	16 Service cable glands
07 Scheda di ingresso DC	17 Anticondensation valve
08 DC disconnect switch	18 DC cable glands
09 bracket mounting slot	19 Input connectors (MPPT1)
10 Inverter	20 Input connectors (MPPT2)

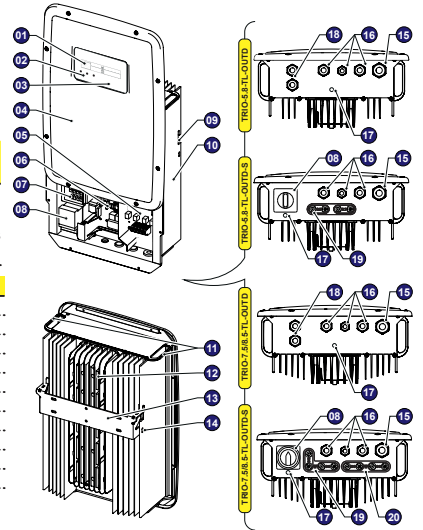

3. Choice of installation location

Environmental checks

- Consult the technical data to check the environmental parameters to be observed
- Installation of the unit in a location exposed to direct sunlight must be avoided as it may cause:
 1. power limitation phenomena in the inverter (with a resulting decreased energy production by the system)
 2. premature wear of the electrical/electromechanical components
 3. premature wear of the mechanical components (gaskets) and of the user interface (display)
- Do not install in small closed rooms where air cannot circulate freely
- To avoid overheating, always make sure the flow of air around the inverter is not blocked
- Do not install in places where gases or flammable substances may be present
- Do not install in rooms where people live or where the prolonged presence of people or animals is expected, because of the noise (about 50dB(A) at 1 m) that the inverter makes during operation
- Avoid electromagnetic interference that can compromise the correct operation of electronic equipment, with consequent situations of danger.

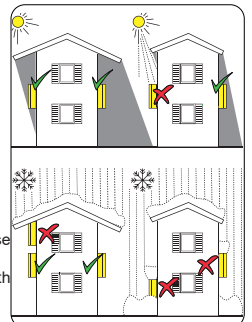

Installations above 2000 metres

On account of the rarefaction of the air (at high altitudes), particular conditions may occur:

- Less efficient cooling and therefore a greater likelihood of the device going into derating because of high internal temperatures
- Reduction in the dielectric resistance of the air that, in the presence of high operating voltages (DC input), can create electric arcs (discharges) that can reach the point of damaging the inverter

NOTE – All installations at altitudes of over 2000 metres must be assessed case by case by the FIMER Service department.

Installation position

- Install on a wall or strong structure suitable for bearing the weight
- Install in safe, easy to reach places
- If possible, install at eye-level so that the display and status LEDs can be seen easily
- Install at a height that considers the heaviness of the equipment
- Install vertically with a maximum inclination of +/- 5°
- To carry out maintenance of the hardware and software of the equipment, remove the covers on the front. Check that there are the correct safety distances for the installation that will allow the normal control and maintenance operations to be carried out
- Comply with the indicated minimum distances
- For a multiple installation, position the inverters side by side
- If the space available does not allow this arrangement, position the inverters in a staggered arrangement as shown in the figure so that heat dissipation is not affected by other inverters

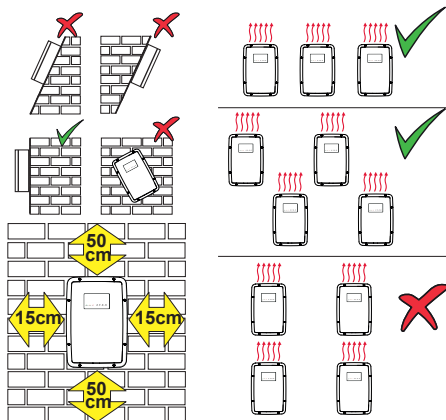

ATTENTION – Final installation of the inverter must not compromise access to any disconnection devices that may be located externally.

ATTENTION – Please refer to the warranty terms and conditions available on the website and evaluate any possible exclusion due to improper installation.

4. Instruments

LEDs and BUTTONS, in various combinations, can be used to view the status or carry out complex actions that are described more fully in the manual.

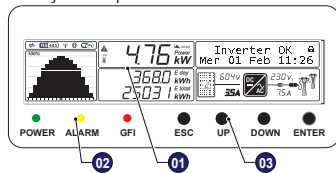

POWER LED	GREEN On if the inverter is working correctly. Flashes when checking the grid or if there is insufficient sunlight.
ALARM LED	YELLOW The inverter has detected an anomaly. The anomaly is shown on the display.
GFI LED	RED Ground fault on the DC side of the PV generator. The error is shown on the display.

ESC	It is used to access the main menu, to go back to the previous menu or to go back to the previous digit to be edited.
UP	It is used to scroll up the menu options or to shift the numerical scale in ascending order.
DOWN	It is used to scroll down the menu options or to shift the numerical scale in descending order.
ENTER	It can be used to confirm an action, to access the submenu for the selected option (indicated by the > symbol) or to switch to the next digit to be edited.

The operating parameters of the equipment are displayed through the display (01): warnings, alarms, channels, voltages, etc.

Description of symbols and display fields.

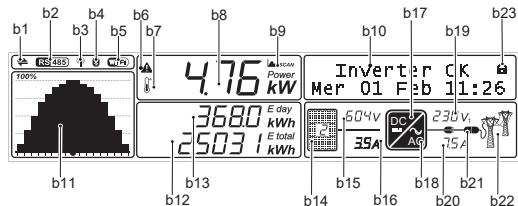

Description of symbols and display fields.

b1 RS485 data transmission	b13 Daily energy produced
b2 RS485 line present	b14 PV voltage > Vstart
b3 Radio line present.	b15 DC voltage value
b4 Bluetooth line present (*)	b16 DC current value
b5 WiFi line present (*)	b17 DC/DC circuit part
b6 Warning	b18 DC/AC circuit part
b7 Temperature derating	b19 AC voltage value
b8 Instantaneous power	b20 AC current value
b9 MPP scan running	b21 Connection to the grid
b10 Graphic display	b22 Grid status
b11 Power graph	b23 Cyclic view on/off
b12 Total energy	(*) NOT available

5. Lifting and transport

Transport and handling

Transport of the equipment, especially by road, must be carried out with by suitable ways and means for protecting the components (in particular, the electronic components) from violent shocks, humidity, vibration, etc.

Lifting

Where indicated and/or where there is a provision, eyebolts or handles, which can be used as anchorage points, are inserted and/or can be inserted.

The ropes and means used for lifting must be suitable for bearing the weight of the equipment.

Unpacking and checking





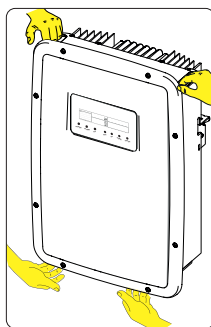



The components of the packaging must be disposed of in accordance with the regulations in force in the country of installation.

When you open the package, check that the equipment is undamaged and make sure all the components are present. If you find any defects or damage, stop unpacking and consult the carrier, and also promptly inform the FIMER.





Model	Mass weight	Lifting points n°#
TRIO-5.8-TL-OUTD(-S)-400	25 kg	4
TRIO-7.5-TL-OUTD(-S)-400	28 kg	4
TRIO-8.5-TL-OUTD(-S)-400	28 kg	4

6. List of supplied components

Components available for all models	Quantity
	Connector for connecting the configurable relay 2
	Connector for the connection of the communication and control 2 signals 2
	L-key, TORX TX25 1
	Two-hole gasket for M25 signal cable glands and cap 2+2
	Two-hole gasket for M20 signal cable glands and cap 1+1
	Three-hole gasket for M25 DC cable glands and cap 2+4
	Bracket for wall mounting+ Locking screw 1+2
	Bolts and screws for wall mounting 4+4
	Quick Installation Guide 1

Additional components for 7.5 / 8.5kW models	Quantity
	Jumpers for configuration of the parallel input channels 1+1

Additional components for models with disconnect switch (-S)	Quantity
	Female quick fit connectors 2 (5.8 kW) 4 (7.5 / 8.5 kW)
	Male quick fit connectors 2 (5.8 kW) 4 (7.5 / 8.5 kW)

7. Assembly Instruction

Wall mounting

During installation do not place the inverter (10) with the front cover (04) facing towards the ground.

- Position the bracket (13) perfectly level on the wall and use it as a drilling template.
- Drill the 4 holes required using a drill with 10mm bit. The holes must be about 70mm deep.
- Fix the bracket to the wall with the 4 wall anchors, 10mm in diameter, supplied.
- Attach the inverter by inserting the two tabs on the bracket (13) into the 2 slots on the inverter (figures A1 and A2).
- Secure the inverter to the bracket by screwing the 2 lock screws (14) on both sides of the inverter (figure A3).
- Unscrew the 8 screws and open the front cover (04) as described in the following paragraph to make all necessary connections.

The cover is fitted into fixed rails and cannot be removed.

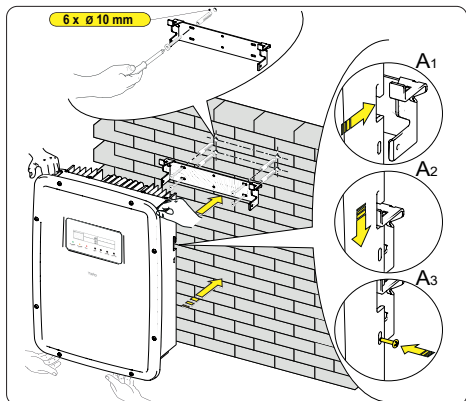

8. Opening the cover

The front cover can be easily opened by sliding it over the two rails on both inner sides of the inverter, as described in the procedure below:

- Unscrew the 8 screws that secure the front cover (04) (step 1)
 - Open the cover by pulling it towards you, then push it upwards from both sides (steps 2 and 3).
- At this stage, avoid misplacing the cover.**
- Secure the cover open by pushing it forwards and then downwards (steps 4 and 5)

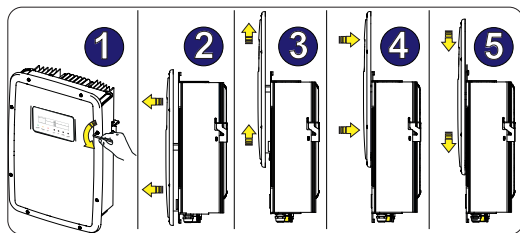

9. Line cable and protection devices

Load protection breaker (AC disconnect switch) and line cable sizing

To protect the AC connection line of the inverter, we recommend installing a device for protection against over current and leakage with the following characteristics:

TRIO-5.8/7.5/8.5-TL-OUTD	
Type	Automatic circuit breaker with differential thermal magnetic protection
Voltage/Current rating	400V /16A
Magnetic protection characteristic	B/C
Number of poles	3/4
Type of differential protection	A/IAC
Differential sensitivity	30mA

FIMER declares that the FIMER transformerless inverters, in terms of their construction, do not inject continuous ground fault currents and therefore there is no requirement that the differential protection installed downstream of the inverter be type B in accordance with IEC 60755 / A 2.

Characteristics and sizing of the line cable

For the connection of the inverter to the grid, you can choose between a star connection (3 phases + neutral) and a delta connection (3 phases). The cross-section of the AC line conductor must be sized in order to prevent unwanted disconnections of the inverter from the grid due to high impedance of the line that connects the inverter to the power supply point

Cross-section of the line conductor (mm ²)	Maximum length of the line conductor (m)		
	TRIO-5.8-TL-OUTD	TRIO-7.5-TL-OUTD	TRIO-8.5-TL-OUTD
4	55m	40m	35m
6	80m	60m	55m
10	135m	105m	90m

The values are calculated in nominal power conditions, taking into account:

- a power loss of not more than 1% along the line.
- copper cable, with HEPR insulation, laid in free air

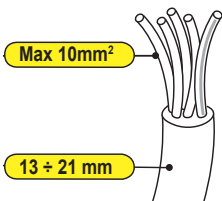

10. Input configuration (DC)

The 7.5 and 8.5 kW power inverter versions are equipped with two independent input channels (and therefore with double maximum power point tracker MPPT), which can however be connected in parallel using a single MPPT.

•Independent channel configuration (default configuration)

This configuration is factory-set and uses both input channels (MPPT) as independent. This requires the jumpers (supplied) between the positive and negative poles of the two DC input channels not to be installed and the independent channel mode to be set in the relevant section of the SETTINGS menu.



•Parallel channel configuration

This configuration uses the two input channels (MPPT) connected in parallel. This requires the jumpers (supplied) between the positive and negative poles of the two DC input channels to be installed and the parallel channel mode to be set in the relevant section of the SETTINGS menu.

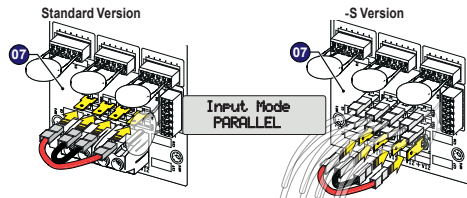

11. Input connection (DC)

⚠ WARNING – Check for correct polarity in the input strings and absence of any leakage to ground in the PV generator. When exposed to sunlight, the PV panels supply DC direct voltage to the inverter. The inside of the inverter may only be accessed after the equipment has been disconnected from the grid and from the photovoltaic generator. The inverter is only to be used with photovoltaic units with ground insulated input poles unless accessories allowing grounding of the inputs have been installed. In this case it is compulsory to install an isolation transformer on the AC side of the system.

•Connection of inputs on the Standard models

The input connections on inverter models that are not equipped with a DC disconnect switch can be made in 2 different modes, based on the number of available input channels.

	TRIO-5.8-TL-OUTD	TRIO-7.5-TL-OUTD	TRIO-8.5-TL-OUTD
No. of input channels	1	2	2
DC cable gland		2 x M25	

For all inverter models the DC terminal block (23) can be connected by feeding the cables inside the DC cable glands (18). The cable gland accepts cables of maximum diameter from 10 to 17 mm, while each terminal of the terminal block accepts a cable with maximum cross-section of 16 mm² (1.5 Nm tightening torque). Unscrew the cable gland, remove the cover, feed a cable of suitable cross-section and connect it to the terminals on the DC input terminal block.

Three-hole gaskets are supplied for insertion in the cable gland, which allow three separate cables with cross-section of up to 7mm to go through.

Once the connection to the terminal block has been made, firmly screw the cable gland (7.5 Nm tightening torque) and check the tightness.

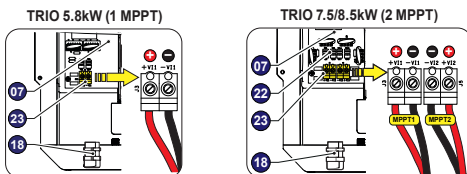

•Connection of inputs on models with disconnect switch

The string connections for inverter versions equipped with DC disconnect switch (08) use quick fit connectors (multicontact or weidmuller), placed at the bottom of the mechanism.

The number of quick fit connectors changes based on the number of input channels. Each input channel is normally equipped with two pairs of connectors for the connection of two strings.

	TRIO-5.8-TL	TRIO-7.5-TL	TRIO-8.5-TL
No. of input channels	1	2	
No. of quick fit connectors	4 (2 pairs)	4 + 4 (2 pairs per MPPT)	

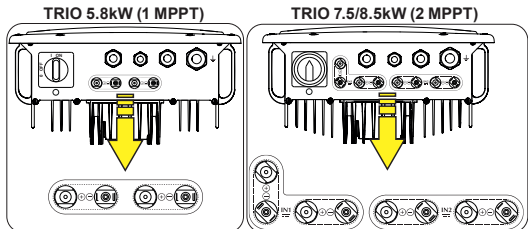

Connect all the strings included in the system design and always check the tightness of the connectors.

If some of the string inputs are left unused, check that all relevant connectors are covered with caps and install caps where needed. This is necessary to ensure the tightness of the inverter and to avoid damaging the unused connectors so that they can be ready for later use.

12. Output connection (AC)

The inverter should be connected to a three-phase system with an earthed common star point. When connecting the inverter to the network, either a four-wire connection (3 phases + neutral) or a three-wire connection (3 phases) can be used.

⚠ ATTENTION – Whichever connection is used, the inverter must be connected to earth. To avoid the risk of electrocution, all connection operations must be carried out with the disconnecter downstream from the disarmed inverter (network side).

For all models, connection is carried out with the AC (31) output terminal by passing the cables through the inside of the AC cable gland (15). The maximum accepted cable diameter is between 13 and 21 mm; however, each individual clamp in the terminal accepts a cable with a maximum section view of 10 mm² (tightening torque 1.5 Nm).

Unscrew the cable gland, remove the plug, insert the appropriately sized cable, and connect the conductors (Neutral, R, S, T and Ground) to the clamps on the AC output terminal (31). Take care to not invert one of the phases with neutral!

Once connection to the terminals is completed, securely retighten the screws (tightening torque 8.0 Nm) on the cable gland and check the sealing barrier.

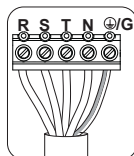
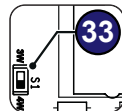
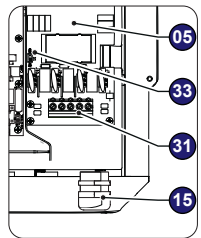

Set up the S1 (33) switch based on the configuration of the output connections:

- position 3W for three-wire configurations (R+S+T)
- position 4W for four-wire configurations (R+S+T+Neutral)

13. Connection of the communication and control signals

The following table shows the main components and the connections available on the control and communication board.. Each cable that must be connected to the communication card must go through the three service cable glands (16).

Ref. manual	Ref. inverter	Description
(24)	J14	SLOT 3 - Connector for WIFI modules installation (NOT ACTIVE)
a01	A2	Inverter data memory card housing
(25)	A1	SD CARD housing
a02	S2	Switch to set the inverter to normal or service mode
a03	BT1	Battery housing
(26)	J2	Terminal block connecting to the configurable relay that allows connection of external devices which, according to the mode selected in the menu SETTINGS>Alarm can, for example, signal malfunctions. The operating modes that can be set are: -Production -Alarm -Alarm (configurable) -Crepuscolar
(30)	J7 e J11	Connection of the RS485 (PC) line on RJ45 connector
(27)	J9	Connector for radiomodule or Ethernet board installation
(28)	J3	SLOT 2 - Connector for PMU board installation
a04	A3	RS485 (PC) communication card housing
(29)	J4	Terminal block for: - PC RS485 serial connection (to connect local or remote monitoring systems) - Remote ON/OFF connection - Tachometer signal (WIND version) connection
a05	S2	Switch for setting the termination resistance of the RS485 (PC) line

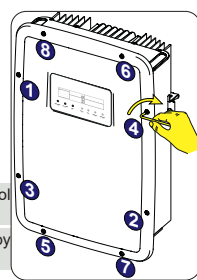
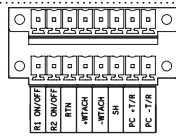
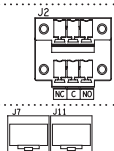
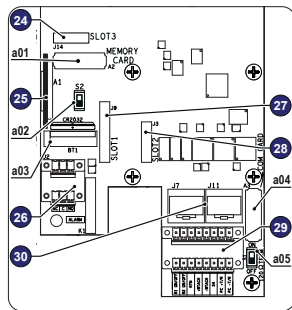

READ THE MANUAL – Please refer to the manual for details of the connections and functions available on the control and communication board

NOTE – Once the connection and the configuration of the inverter is completed, the front cover must be closed by tightening the screws (2.4 Nm tightening torque) in the order shown.

14. Commissioning

The inverter commissioning procedure is as follows:

- Close the AC disconnect switch to supply the inverter with the grid voltage
- Close the DC disconnect switch to supply the inverter with the photovoltaic generator voltage.
- If the inverter is equipped with a DC disconnect switch (-S models), turn the DC disconnect switch (14) to the ON position.
- When the inverter is connected to the power supply, the display will show a guided configuration procedure. Press ENTER to set the following:

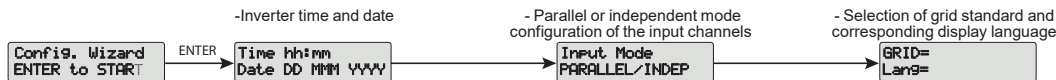

Once the guided configuration is completed, the inverter restarts to apply the parameter settings

- When the inverter has power, the first check performed is the one relating to the input voltage:
 - If the DC input voltage is lower than the Vstart voltage (voltage required to begin the inverter's grid connection) the b14 icon remains off and the "Waiting sun" message is displayed b10.
 - If the DC input voltage is higher than the Vstart voltage the b14 icon is displayed and the inverter goes to the next stage of the controls.
- In both cases the voltage levels and input current are displayed in the b15 and b16 fields.
- The inverter performs a control of grid parameters. The b22 icon, which represents the grid distribution, can have different statuses:
 - not present, if the mains voltage results as absent.
 - flashing, if the mains voltage is present but outside the parameters dictated by the standard of the country of installation.
 - turns on, if the mains voltage is present and within the parameters dictated by the standard of the country of installation. In this condition, the inverter starts the sequence of grid connection.

ATTENTION – Do not place objects of any kind on the inverter during operation!
Do not touch the heatsink while the inverter is operating! Some parts may be very hot and cause burns.

READ THE MANUAL – If the input voltage and the grid voltage are within the inverter operating intervals, connection to the grid will commence. After the inverter is connected, the icons on the whole line b21 will come on steady.
Once the connection sequence has been completed, the inverter starts to operate and indicates its correct operation by making a sound and by the green LED coming on steady on the LED panel (02).

- Check for updated Firmware versions on the website

If the inverter signals any errors/warnings the messages and their codes will be indicated on the display (01). This state will also cause switching of the multi-function relay (set to alarm mode in the menu SETTINGS>Alarm) which activates any external signalling device that may be connected.

15. Components & accessories

The accessories can be bought separately and installed directly by a qualified technician or by the installer. For information on the installation, compatibility and use of the accessories, refer to the relevant part documentation.

PMU EXPANSION BOARD

Added features:

- PMU - Management of active/reactive power
- 2 analogue and 1 PT100/ PT1000 inputs.
- Analogue sensor power supply (24 V)
- RS485 (ModBus protocol)
- RS485 (Aurora protocol)

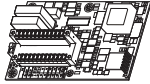

ETHERNET EXPANSION BOARD

Added features:

- Ethernet connection for:
- Local monitoring (internal webserver)
- Remote monitoring ("Aurora Vision/Easy View" portal)

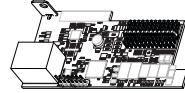

16. Structure of the display menu

The display (01) has a section b10 (graphic display) for moving through the menu using the buttons of the LED panel (02). Section b10 consists of 2 lines with 16 characters per line:

Viewing of the **GENERAL INFORMATION** is cyclic. This information relates to the input and output parameters and the inverter identification parameters. By pressing ENTER it is possible to lock scrolling on a screen to be constantly displayed.

Press ESC to access the three main menus, which have the following functions:
STATISTICS>Displays the statistics;
SETTINGS>Modify the settings of the inverter
INFO>View service messages for the operator;

Refer to the manual for details regarding use and functions available in the menu.

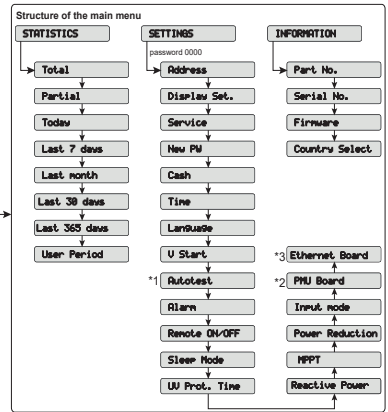
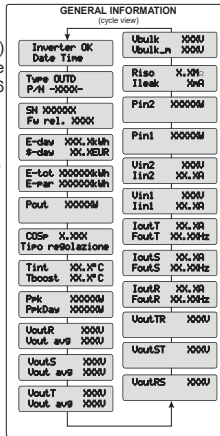

*1 Available only for grid standard CEI-021
 *2 Available only with PMU board installed
 *3 Available only with Ethernet board installed

17. Characteristics and technical data

TRIO-5.8-TL-OUTD

TRIO-7.5-TL-OUTD

TRIO-8.5-TL-OUTD

Input Side	TRIO-5.8-TL-OUTD	TRIO-7.5-TL-OUTD	TRIO-8.5-TL-OUTD
Absolute maximum input voltage ($V_{max,abs}$)	1000 V		
Start-up DC Input Voltage (V_{start})	350 V (adj. 200...500 V)		
Operating DC input voltage range ($V_{dmin}...V_{dmax}$)	0.7 x V_{start} ...950 V		
Rated input DC power (P_{ref})	5950 Wp	7650 Wp	8700 Wp
Number of independent MPPTs	1	2	2
Maximum Input power for each MPPT ($P_{MPPTmax}$)	6050W/Linear Derating From MAX to Null [800V≤VMPPT≤950V]	4800 W	4800 W
DC input voltage range ($V_{MPPT,min}...V_{MPPT,max}$) at Pacr	320...800 V		
DC Input Voltage Range with Parallel Configuration of MPPT at Pacr	-	320...800 V	320...800 V
DC Power Limitation with Parallel Configuration of MPPT	-	Linear Derating From MAX to Null [800V≤VMPPT≤950V]	
DC Power Limitation for each MPPT with Independent Configuration of MPPT at Pacr , max unbalance example	-	4800 W [320V≤VMPPT≤800V] the other channel: Pdcr-4800W	4800 W [320V≤VMPPT≤800V] the other channel: Pdcr-4800W
Maximum DC Input Current ($I_{dc,max}$) / for each MPPT ($I_{MPP,max}$)	18.9 A	30 A / 15 A	30 A / 15 A
Maximum Backfeed current (from AC to DC side)	Negligible		
Number of DC Inputs Pairs for each MPPT	2 (-S Version)		
DC Connection Type	Tool Free PV Connector WM / MC4 (Screw Terminal Block on Standard Version)		
Type of photovoltaic panels that can be connected at input according to IEC 61730	Classe A		
Input protection			
Reverse polarity protection	Yes, from a limited current source		
Input overvoltage protection for each MPPT-Varistor	2		

	TRIO-5.8-TL-OUTD	TRIO-7.5-TL-OUTD	TRIO-8.5-TL-OUTD
Maximum Input Short Circuit Current for each MPPT	24.0 A	20.0 A	20.0 A
Photovoltaic Array Isolation Control	According to local standard		
DC Switch Rating for each MPPT (Version with DC Switch)	13 A / 1000 V	23 A / 800 V	
Output Side			
AC Grid Connection Type	Three phase 3W or 4W+PE		
Rated AC grid voltage (V _{act})	400 V		
AC Voltage Range	320...480 Vac ⁽¹⁾		
Rated AC Power (P _{ac,max@cosφact})	5800 W	7500 W	8500 W
Maximum apparent power (S _{max})	5800 VA	7500 VA	8500 VA
Maximum AC output current (I _{ac,max})	10.0 A	12.5 A	14.5 A
Contributory fault current	12.0 A	14.5 A	16.5 A
Inrush Current	Negligible		
Maximum output fault current	<20Arms(100mS)		
Rated output frequency (f)	50 / 60 Hz		
Output frequency range (f _{min} ...f _{max})	47...53 / 57...63 Hz ⁽²⁾		
Nominal Power Factor and adjustable range (Cosφiacr)	>0.995, adj.±0.9 with Pacr=5.22kW, adj. ± 0.8 with max 5.8kVA	>0.995, adj.±0.9 with Pacr=6.75kW, adj. ± 0.8 with max 7.5kVA	>0.995,adj.±0.9 with Pacr=7.65kW, adj. ± 0.8 with max 8.5kVA
Total current harmonic distortion	< 2%		
AC connection type	Screw terminal block, maximum cross-section 10 mm ²		
Output Protection			
Anti-islanding protection	According to local standard		
Maximum AC overcurrent protection	10.5 A	12.0 A	15.0 A
Output overvoltage protection - Varistor	4 plus gas arrester		
Operating Performance			
Maximum efficiency (η _{max})	98.0%		
Weighted efficiency (EURO/CEC)	97.4% / -		
Feed In Power Threshold	32 W	36 W	36 W
Stand-by Consumption	< 15 W		
Communication			
Wired Local Monitoring	Ethernet card with webserver (opt.), PVI-USB-RS232_485 (opt.), PVI-DESKTOP (opt.)		
Remote Monitoring	Ethernet card (opt.), PVI-AEC-EVO (opt.), VSN700 Data Logger (opt.)		
Wireless Local Monitoring	PVI-DESKTOP (opt.) with PVI-RADIOMODULE (opt.)		
User Interface	Graphic display		
Environmental			
Ambient temperature range	-25...+60°C / -13...140°F con derating sopra i 50°C/122°F		
Relative humidity	0...100% condensing		
Noise Emission	< 45 db(A) @ 1 m		
Maximum Operating Altitude without Derating	2000 m / 6560 ft		
Environmental pollution classification for external environment	3		
Environmental category	External		
Physical			
Environmental Protection Rating	IP 65		
Cooling system	Natural		
Overvoltage Category in accordance with IEC 62109-1	II (DC input) III (AC output)		
Dimensions (H x W x D)	641mm x 429mm x 220mm / 25.2" x 16.9" x 8.7"		
	855mm x 429mm x 237mm / 33.7" x 16.9" x 9.3" with open front cover		
Weight	25.0 kg / 55.1 lb	28.0 kg / 61.7 lb	28.0 kg / 61.7 lb
Mounting system	Wall bracket		
Safety			
Isolation level	Transformerless		
Marking	CE (50Hz only)		
Safety class	I		

1. The AC voltage range may vary depending on specific country grid standard

2. The Frequency range may vary depending on specific country grid standard

Remark. Features not specifically listed in the present data sheet are not included in the product



For more information please contact your local FIMER representative or visit:

fimer.com

We reserve the right to make technical changes or modify the contents of this document without prior notice. With regard to purchase orders, the agreed particulars shall prevail. FIMER does not accept any responsibility whatsoever for potential errors or possible lack of information in this document.

We reserve all rights in this document and in the subject matter and illustrations contained therein. Any reproduction, disclosure to third parties or utilization of its contents – in whole or in parts – is forbidden without prior written consent of FIMER. Copyright© 2021 FIMER. All rights reserved.